



GUIDE TO SERVICES **2018**

www.guernseypost.com



Bailiwick Post

■ Postcard, Letter, Large Letter & Parcel <i>(formerly known as Packet)</i>	2
■ Large Parcel	3
■ Signed For	3

UK, Isle of Man, Jersey Post

■ Postcard, Letter, Large Letter & Parcel <i>(formerly known as Packet)</i>	4
■ Large Parcel	5
■ Signed For	5

European Post

■ Postcard, Letter, Large Letter & Parcel <i>(formerly known as Packet)</i>	6
■ Global Priority Large Parcels	7
■ Global Value Large Parcels	7

Please refer to p13-14 for European/Rest of World Large Parcel Weight Limits

Rest of World Post

■ Postcard, Letter, Large Letter & Parcel <i>(formerly known as Packet)</i>	8
■ Global Priority Large Parcels	9
■ Global Value Large Parcels	9

Please refer to p10-12 for International Tracked, Signed, Tracked & Signed

European & Rest of World

Tracked Services *and Parcel Weight Limits*

■ International Tracked, Signed, Tracked & Signed	10 - 12
■ European/Rest of World Large Parcel Weight Limits	13 - 14

Bailiwick Postal Rates

Postcard

Min: 90mm x 140mm

Max: 235mm x 120mm x 5mm

Letter

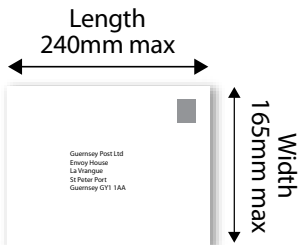

Thickness 5mm max

Weight 100g max

Minimum Size

The minimum length for any item posted is 140mm, minimum width 90mm, and the minimum thickness is 0.25mm.

Large Letter

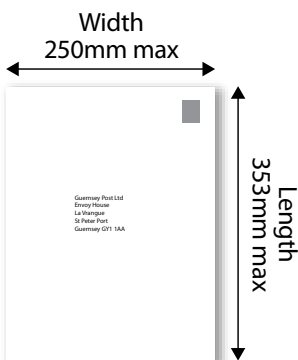

Thickness 25mm max

Weight 750g max

Parcel (formerly Packet)

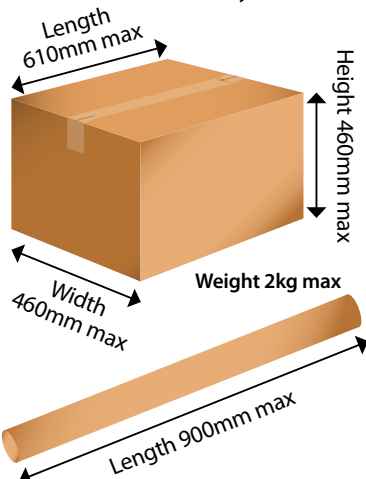

Item weight not over	Letter	Large Letter	Parcel
POSTCARD	£0.46	-	-
100g	£0.46	£0.63	£1.01
250g	-	£1.10	-
500g	-	£1.55	£1.96
750g	-	£1.95	-
1000g	-	-	£3.14
1500g	-	-	£4.34
2000g max	-	-	£5.54

The most economical way to send an item by post is by using a standard DL or C5 envelope.

A Letter is anything sent in a regular-sized envelope in everyday use i.e. half the size of a sheet of A4 or smaller, less than 5mm thick and under 100g in weight. Popular items that qualify for this format include letters, small birthday cards, sleeved CDs and sleeved DVDs.

A Large Letter is any item that is less than 353mm long, less than 250mm wide, under 750g in weight and up to 25mm thick for Bailiwick.

Popular postal items that fit into the Large Letter format include A4 papers in C4 envelopes, magazines, brochures and boxed CDs and DVDs.

A Parcel (formerly known as Packet), or small package, is anything larger in size than a Large Letter, so more than 353mm long, or more than 250mm wide, or more than 25mm thick but under 610mm long, 460mm wide or 460mm high.

Some examples of items that can be sent by parcel are trainers, books and clothes.

Parcel (formerly known as Packet) (rolled item)

The Parcel format is also designed for cylindrical items that are no longer than 900mm, with the length of the item plus twice the diameter not exceeding 1040mm.

Standard Insurance - Insured up to £4.60

Your receipt must be retained as proof of posting of your item and represents your acceptance of the Terms and Conditions of carriage. It must be provided if you need to make a claim for damage or loss, together with proof of the cost of the item.

Terms and Conditions:

These Terms and Conditions apply to all services unless specified under each section.

- There is no compensation available for prohibited items (please refer to pages 41 - 53 for prohibited items). or items of value that should have been sent by Special Delivery e.g. money, jewellery, diamonds etc.
- You must retain your receipt and provide it if you make a claim for compensation together with proof of the cost of the item.
- The item must be properly packed and addressed.

Claims

To make a claim you must complete and submit the Claim Form available from any Guernsey Post branch or our website.

We reserve the right to raise a surcharge for underpaid post (£1.00 plus twice the underpaid amount). This surcharge will be sought from the recipient upon delivery.

Bailiwick Postal Rates

Large Parcel

Width + Height + Length must not exceed 3 metres maximum

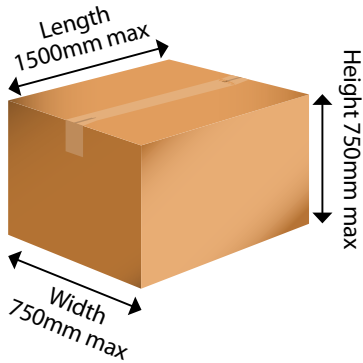

A **Large Parcel** is any item up to 1.5 metres long, 750mm high and up to 30kg in weight.

The combined length, width and height for a Large Parcel must not exceed 3 metres. Items typically sent are printers, duvets and golf clubs.

Item weight not over	Insurance Up to £50	Insurance Up to £250	Insurance Up to £500
5kg	£9.00	£11.50	£14.00
10kg	£12.00	£14.50	£17.00
20kg	£15.00	£17.50	£20.00
30kg max	£18.00	£20.50	£23.00

Although it is not guaranteed, our local Large Parcel service normally provides delivery to any Bailiwick address within two days of posting for heavy items.

Large Parcel Insurance

Insurance up to £50 is standard for Large Parcels posted to Bailiwick addresses with the option to increase the level of insurance (see prices). *Note: Ceramics and glassware are not covered by insurance.* It is important that all Large Parcels are adequately wrapped and packed to prevent items being damaged.

Please see page 36 of the 'Posting Information' section for more details.

See left for size limits. For more information on our claims procedures please visit our website or contact our customers services team on 01481 711720.

Signed For

(formerly known as Recorded Delivery)



Item weight not over	Letter	Large Letter	Parcel
100g	£1.56	£1.73	£2.11
250g	-	£2.20	-
500g	-	£2.65	£3.06
750g	-	£3.05	-
1000g	-	-	£4.24
1500g	-	-	£5.44
2000g max	-	-	£6.64

Letters and parcels can be sent by **Signed For** within the Bailiwick. Proof of posting (a receipt) is issued at the time of posting and a signature is required on delivery at the destination address.

This service is not tracked but if you require a tracked service see 'Special Delivery' on page 17.

Benefits:

- Proof of posting.
- Signature on delivery.
- Confirmation of delivery of an item can be obtained online or by calling Customer Services on 711720.
- Includes insurance up to a maximum of £46 for items sent locally or the market value, whichever is the smaller sum, subject to proof of cost.

UK, Isle of Man, Jersey Postal Rates

Postcard

Min: 90mm x 140mm

Max: 235mm x 120mm x 5mm

Letter

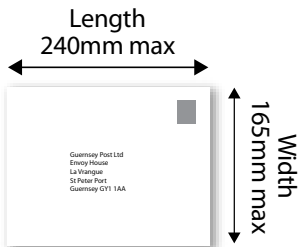

Thickness 5mm max

Weight 100g max

Minimum Size

The minimum length for any item posted is 140mm, minimum width 90mm, and the minimum thickness is 0.25mm.

Large Letter

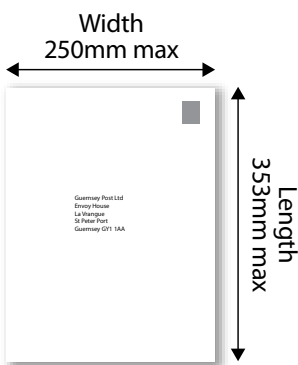

Thickness 25mm max

Weight 750g max

Parcel (formerly Packet)

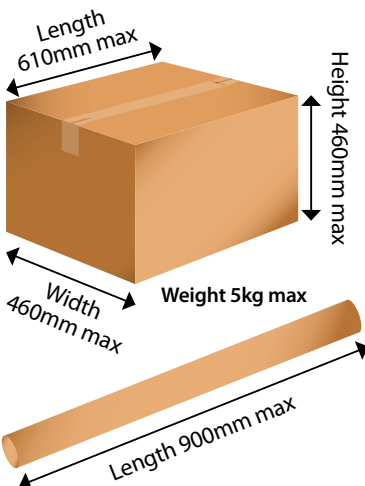

Item weight not over	Letter	Large Letter	Parcel
POSTCARD	£0.62	-	-
100g	£0.62	£0.94	-
250g	-	£1.64	-
500g	-	£2.64	£3.75
750g	-	£3.50	-
1000g	-	-	£5.50
1500g	-	-	£8.00
2000g	-	-	£10.50
3000g	-	-	£16.25
4000g	-	-	£21.25
5000g max	-	-	£26.25

The most economical way to send an item by post is by using a standard DL or C5 envelope.

A Letter is anything sent in a regular-sized envelope in everyday use i.e. half the size of a sheet of A4 or smaller, less than 5mm thick and under 100g in weight. Popular items that qualify for this format include letters, small birthday cards, sleeved CDs and sleeved DVDs.

A Large Letter is any item that is less than 353mm long, less than 250mm wide, under 750g in weight and up to 25mm thick for UK, Isle of Man and Jersey.

Popular postal items that fit into the Large Letter format include A4 papers in C4 envelopes, magazines, brochures and boxed CDs and DVDs.

A Parcel (formerly known as Packet), or small package, is anything larger in size than a Large Letter, so more than 353mm long, or more than 250mm wide, or more than 25mm thick but under 610mm long, 460mm wide or 460mm high.

Some examples of items that can be sent by Parcel are trainers, books and clothes.

Parcel (formerly known as Packet) (rolled item)

The Parcel format is also designed for cylindrical items that are no longer than 900mm, with the length of the item plus twice the diameter not exceeding 1040mm.

Standard Insurance - Insured up to £6.20

Your receipt must be retained as proof of posting of your item and represents your acceptance of the Terms and Conditions of carriage. It must be provided if you need to make a claim for damage or loss, together with proof of the cost of the item.

Terms and Conditions:

These Terms and Conditions apply to all services unless specified under each section.

- There is no compensation available for prohibited items (please refer to page 41 - 53 for prohibited items), or items of value that should have been sent by Special Delivery e.g. money, jewellery, diamonds etc.
- You must retain your receipt and provide it if you make a claim for compensation together with proof of the cost of the item.
- The item must be properly packed and addressed.

Claims

To make a claim you must complete and submit the Claim Form available from any Guernsey Post branch or our website.

We reserve the right to raise a surcharge for underpaid post (£1.00 plus twice the underpaid amount). This surcharge will be sought from the recipient upon delivery.

UK, Isle of Man, Jersey Postal Rates

Large Parcel

Width + Height + Length must not exceed 3 metres maximum

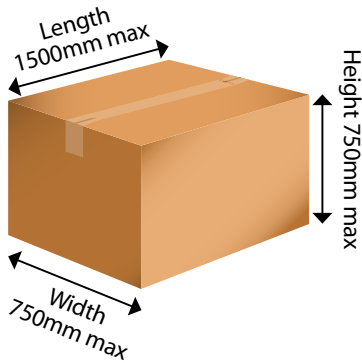

A **Large Parcel** is any item up to 1.5 metres long, 750mm high and up to 30kg in weight.

The combined length, width and height for a Large Parcel must not exceed 3 metres. Items typically sent are printers, duvets and golf clubs.

Item weight not over	Insurance Up to £50	Insurance Up to £250	Insurance Up to £500
5kg	£12.40	£14.90	£17.40
10kg	£16.00	£18.50	£21.00
20kg	£25.00	£27.50	£30.00
30kg max	£35.00	£37.50	£40.00

We operate a speedy and efficient service for Large Parcel items to Jersey, the UK and the Isle of Man.

Parcel Insurance

Although not guaranteed, our Large Parcel service normally offers delivery within three to four days for heavy items sent to the UK, Jersey and the Isle of Man.

Insurance up to £50 is standard for Large Parcels posted to UK, Jersey and Isle of Man addresses with the option to increase the level of insurance (see prices). *Note: Ceramics and glassware are not covered by insurance.* It is important that all Large Parcels are adequately wrapped and packed to prevent items being damaged.

Please see page 36 of the 'Posting Information' section for more details.

See above left for size limits. For more information on our claims procedures please visit our website or contact our customers services team on 01481 711720.

Signed For

(formerly known as Recorded Delivery)



Item weight not over	Letter	Large Letter	Parcel
100g	£1.72	£2.04	-
250g	-	£2.74	-
500g	-	£3.74	£4.85
750g	-	£4.60	-
1000g	-	-	£6.60
1500g	-	-	£9.10
2000g	-	-	£11.60
3000g	-	-	£17.35
4000g	-	-	£22.35
5000g max	-	-	£27.35

Letters and parcels can be sent by Signed For within the UK, Jersey and the Isle of Man. Proof of posting (a receipt) is issued at the time of posting and a signature is required on delivery at the destination address.

This service is not tracked but if you require a tracked service see 'Special Delivery' on page 16.

Benefits:

- Proof of posting.
- Signature on delivery.
- Confirmation of delivery of an item can be obtained online or by calling Customer Services on 711720.
- Includes insurance up to a maximum of £62 for items sent to UK, Jersey or Isle of Man, or the market value, whichever is the smaller sum, subject to proof of cost.

European Postal Rates

Postcard

Min: 90mm x 140mm

Max: 235mm x 120mm x 5mm

Letter

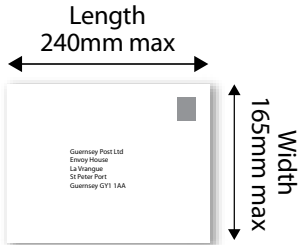

Thickness 5mm max

Weight 100g max

Large Letter

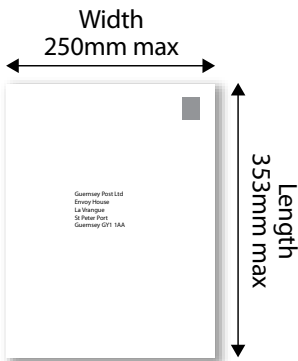

Thickness 20mm max

Weight 750g max

If your Large Letter is large or bulky, be sure to mark it clearly with the words 'LETTER' and 'AIRMAIL' on the outside. Standard Insurance - £50 max.

Parcel (formerly Packet)

Maximum size: Length, width and depth combined - 900mm

The greatest single dimension must not exceed - 600mm

Length must not exceed 900mm

Maximum weight - 2kg

Roll: Length plus twice diameter must not exceed - 1040mm

Item weight not over	Letter	Large Letter	Parcel
POSTCARD	£0.76	-	-
20g	£0.76	-	-
100g	£1.54	£1.81	£2.27
250g	-	£3.49	£4.07
500g	-	£5.61	£6.50
750g	-	£8.46	-
1000g	-	-	£12.26
1500g	-	-	£17.90
2000g max	-	-	£23.54

Our Standard International Parcel service is a quick and easy way to send a Parcel to an overseas country. Service levels vary from country to country. If you need a day-definite service, please see 'Express Services' from page 19.

Make sure you mark your Parcel clearly with the word 'AIRMAIL' on the outside.

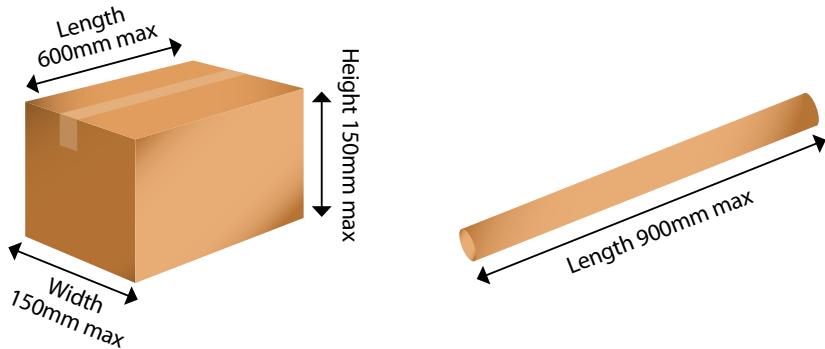

**USE OUR ONLINE
POSTAGE CALCULATOR
WWW.GUERNSEYPOST.COM**

European Postal Rates

Global Priority Large Parcels

Global Priority offers you the perfect balance between speed and price with delivery from 4 working days to Europe.

Tracking for international items only applies to certain postal jurisdictions.

- Maximum Large Parcel sizes and weight limits vary by destination. For more information see pages 13-14, contact Customer Services on 711720 or visit www.guernseypost.com.
- Item insured up to a maximum value of £50 for loss or damage. See website for details.

Additional Insurance

Up to £250	£5.00
------------	-------

Contact Customer Services for weight, size limits and tracking services of a particular country.

	Zone 5	Zone 6	Zone 7	Zone 8	Zone 9
Item weight not over	Republic of Ireland	Belgium, Netherlands, Luxembourg	France, Denmark, Germany	Italy, Spain Portugal, Greece	Rest of Europe
1kg	£26.50	£37.10	£39.22	£42.40	£38.16
2kg	£29.00	£39.35	£41.52	£44.70	£40.31
3kg	£31.50	£41.60	£43.82	£47.00	£42.46
4kg	£34.00	£43.85	£46.12	£49.30	£44.61
5kg	£36.50	£46.10	£48.42	£51.60	£46.76
6kg	£39.00	£48.35	£50.72	£53.90	£48.91
7kg	£41.50	£50.60	£53.02	£56.20	£51.06
8kg	£44.00	£52.85	£55.32	£58.50	£53.21
9kg	£46.50	£55.10	£57.62	£60.80	£55.36
10kg	£49.00	£57.35	£59.92	£63.10	£57.51
11kg	£51.50	£59.60	£62.22	£65.40	£59.66
12kg	£54.00	£61.85	£64.52	£67.70	£61.81
13kg	£56.50	£64.10	£66.82	£70.00	£63.96
14kg	£59.00	£66.35	£69.12	£72.30	£66.11
15kg	£61.50	£68.60	£71.42	£74.60	£68.26
Each extra 1kg	+\$2.50	+\$2.25	+\$2.30	+\$2.30	+\$2.15

Global Value Large Parcels

Where value for money is more important than a guaranteed delivery speed, use Global Value to send your non-urgent items to worldwide destinations.

- 30kg maximum weight limit for individual Large Parcels to most destinations. For more information on weight and size limits see pages 13-14, contact Customer Services on 711720 or visit www.guernseypost.com.
- Insurance is not available for lost, delayed or damaged Large Parcels sent by Global Value.
- No tracking facility is available for this service.

1kg	£13.78	£26.50	£19.08	£31.80	£31.80
2kg	£16.18	£28.65	£21.73	£33.95	£33.65
3kg	£18.58	£30.80	£24.38	£36.10	£35.50
4kg	£20.98	£32.95	£27.03	£38.25	£37.35
5kg	£23.38	£35.10	£29.68	£40.40	£39.20
6kg	£25.78	£37.25	£32.33	£42.55	£41.05
7kg	£28.18	£39.40	£34.98	£44.70	£42.90
8kg	£30.58	£41.55	£37.63	£46.85	£44.75
9kg	£32.98	£43.70	£40.28	£49.00	£46.60
10kg	£35.38	£45.85	£42.93	£51.15	£48.45
11kg	£37.78	£48.00	£45.58	£53.30	£50.30
12kg	£40.18	£50.15	£48.23	£55.45	£52.15
13kg	£42.58	£52.30	£50.88	£57.60	£54.00
14kg	£44.98	£54.45	£53.53	£59.75	£55.85
15kg	£47.38	£56.60	£56.18	£61.90	£57.70
Each extra 1kg	+\$2.40	+\$2.15	+\$2.65	+\$2.15	+\$1.85

Rest of World Postal Rates

Postcard

Min: 90mm x 140mm
Max: 235mm x 120mm x 5mm

Letter

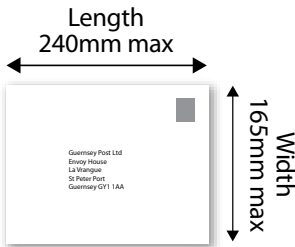

Thickness 5mm max
Weight 100g max

Large Letter

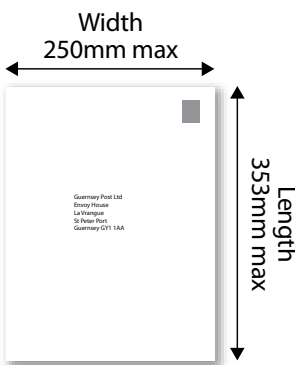

Thickness 20mm max
Weight 750g max

Note: 5mm thinner than UK Large Letters

Parcel (formerly Packet)

Maximum size: Length, width and thickness **combined - 900mm**

The greatest single dimension **must not exceed - 600mm**

Length must **not be greater than - 900mm**

Maximum weight - 2kg

Roll: Length plus twice diameter **must not exceed - 1040mm**

Item weight not over	Letter	Large Letter	Parcel
POSTCARD	£0.85	-	-
20g	£0.85	-	-
100g	£2.31	£2.75	£3.79
250g	-	£5.57	£6.04
500g	-	£9.45	£10.00
750g	-	£11.25	-
1000g	-	-	£15.70
1500g	-	-	£21.20
2000g max			£26.70

**USE OUR ONLINE
POSTAGE CALCULATOR
WWW.GUERNSEYPOST.COM**

Our Standard International Parcel service is the quick and easy way to send a Parcel to an overseas country. Insurance is not available for our Standard International Parcel service and the service levels vary from country to country, so if you need a day-definite service, please go to the 'Express Services' section from page 19, or refer to other Rest of World delivery options pages 8-10.

Make sure you mark your Parcel clearly with the word 'AIRMAIL' on the outside.

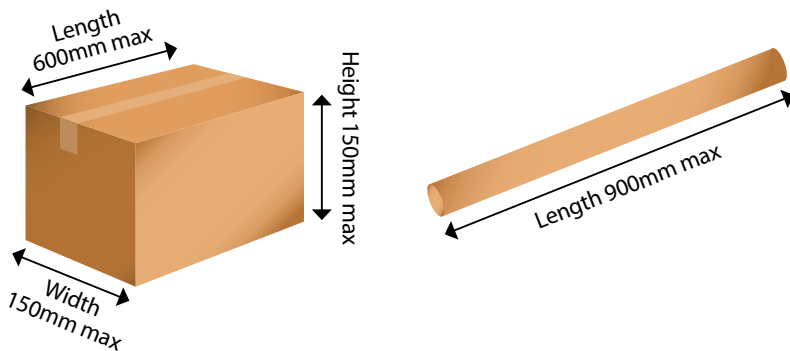

Rest of World Postal Rates

Global Priority Large Parcels

Global Priority offers you the perfect balance between speed and price with delivery from 6 working days to major destinations worldwide.

Tracking for international items only applies to certain postal jurisdictions.

- Maximum Large Parcel sizes and weight limits vary by destination.

For more information see pages 13-14, contact Customer Services on 711720 or visit www.guernseypost.com.

- Item insured up to a maximum value of £50 for loss or damage. See website for details.

Additional Insurance

Up to £250 £5.00

Contact Customer Services for weight, size limits and tracking services of a particular country.

	Zone 10	Zone 11	Zone 12
Item weight not over	USA, Canada	Far East, Australia	Rest of World
1kg	£49.82	£62.54	£66.78
2kg	£57.77	£72.34	£79.53
3kg	£65.72	£82.14	£92.28
4kg	£73.67	£91.94	£105.03
5kg	£81.62	£101.74	£117.78
6kg	£89.57	£111.54	£130.53
7kg	£97.52	£121.34	£143.28
8kg	£105.47	£131.14	£156.03
9kg	£113.42	£140.94	£168.78
10kg	£121.37	£150.74	£181.53
11kg	£129.32	£160.54	£194.28
12kg	£137.27	£170.34	£207.03
13kg	£145.22	£180.14	£219.78
14kg	£153.17	£189.94	£232.53
15kg	£161.12	£199.74	£245.28
Each extra 1kg	+£7.95	+£9.80	+£12.75

Global Value Large Parcels

Where value for money is more important than a guaranteed delivery speed, use Global Value to send your non-urgent items to worldwide destinations.

- 30kg maximum weight limit for individual Large Parcels to most destinations.

For more information on weight and size limits see pages 13-14, contact Customer Services on 711720 or visit www.guernseypost.co

- Insurance is not available for lost, delayed or damaged Large Parcels sent by Global Value.
- No tracking facility is available for this service.

	Zone 10	Zone 11	Zone 12
Item weight not over	USA, Canada	Far East, Australia	Rest of World
1kg	£41.87	£53.00	£54.06
2kg	£48.76	£61.22	£64.40
3kg	£55.65	£69.44	£74.74
4kg	£62.54	£77.66	£85.08
5kg	£69.43	£85.88	£95.42
6kg	£76.32	£94.10	£105.76
7kg	£83.21	£102.32	£116.10
8kg	£90.10	£110.54	£126.44
9kg	£96.99	£118.76	£136.78
10kg	£103.88	£126.98	£147.12
11kg	£110.77	£135.20	£157.46
12kg	£117.66	£143.42	£167.80
13kg	£124.55	£151.64	£178.14
14kg	£131.44	£159.86	£188.48
15kg	£138.33	£168.08	£198.82
Each extra 1kg	+£6.89	+£8.22	+£10.34

European / Rest of World Postal Rates

International Tracked & Signed



Benefits:

- Priority handling.
- Items electronically tracked up to final delivery overseas.
- Automatic insurance up to £50.
- Up to £250 insurance available (exclusions apply, subject to destination and payment of additional fee of £3.00).
- Signature taken on delivery (copy not available).
- Proof of posting.
- *In some countries only* - Returned free of charge if not delivered, providing the return address is supplied.
- Available to 65 countries (see list to the right).

Maximum compensation for cash and money,¹ and instruments sent via International Tracked & Signed is £100. Additional compensation is not available for electronic devices such as mobile telephones, smart phones, tablets, notebooks, personal digital assistants and Blackberrys. Standard compensation is £50.

Loss claims for International Signed to Europe should not be submitted until 20 working days after the estimated delivery date, for items worldwide allow 25 days. All loss claims must be submitted within 6 months of the postal date. See website for details.

¹Cash/money includes coins, notes of any currency, securities of any kind payable to the bearer, travellers cheques and postal orders.

For more information on individual country exclusions, contact Customer Services.

International Tracked & Signed is a fully tracked service from posting to delivery overseas, which requires a signature on delivery. Available from all Guernsey Post branches, International Tracked comes with electronic tracking and operates to 65 countries, although it is not time guaranteed. (See FedEx p19-26 for time guaranteed service.)

International Tracked & Signed is available to selected destinations only:

European Countries:

Aland Islands	Czech Rep. (EU)	Hungary (EU)	Moldova	Slovenia (EU)
Andorra (EU)	Denmark (EU)	Iceland	Netherlands (EU)	Spain (EU)
Austria (EU)	Faroe Islands	Ireland (Rep.)(EU)	Poland (EU)	Sweden (EU)
Belarus	Finland (EU)	Italy (EU)	Portugal (EU)*	Switzerland**
Belgium (EU)	France (EU)**	Latvia (EU)**	Romania (EU)	Turkey
Bulgaria (EU)	Germany (EU)	Liechtenstein	Russian Fed.	Vatican City State (EU)
Canary Isles (EU)	Gibraltar	Lithuania (EU)	San Marino (EU)	
Croatia (EU)	Greece (EU)	Luxembourg (EU)	Serbia	
Cyprus (EU)	Greenland	Malta (EU)	Slovak Rep. (EU)	

Other Countries:

Argentina	Cayman Islands	Indonesia	Singapore	Tonga
Barbados	Cook Islands	Japan	Sth Korea (Rep)	United Arab Emirates
Belize	Ecuador	Lebanon	Thailand	Uganda
Cambodia	Georgia	Malaysia	Trinidad & Tobago	USA
Canada	Hong Kong	New Zealand**		

(EU) - Member of European Union *Additional insurance is not available. **Please note that these International Tracked countries do not allow cash to be sent through their postal networks.

Letter Postage + £6.95

Item weight not over	Europe	Rest of World
20g	£7.71	£7.80
100g max	£8.49	£9.26

Large Letter Postage + £6.95

Item weight not over	Europe	Rest of World
100g	£8.76	£9.70
250g	£10.44	£12.52
500g	£12.56	£16.40
750g	£15.41	£18.20

Parcel¹ Postage + £6.95

Item weight not over	Europe	Rest of World
100g	£9.22	£10.74
250g	£11.02	£12.99
500g	£13.45	£16.95
1000g	£19.21	£22.65
1500g	£24.85	£28.15
2kg max	£30.49	£33.65

Europe/Rest of World Dimensions for International Tracked & Signed

Postcard

Minimum Size	Maximum Size
90mm x 140mm	120mm x 235mm

Letter

Minimum Size	Maximum Size
90mm x 140mm Thickness: 0.25mm	240mm x 165mm Thickness: 5mm

Large Letter

Minimum Size	Maximum Size
166mm x 241mm Thickness: 0.25mm	353mm x 250mm Thickness: 20mm*

* Please note that the maximum Large Letter depth to Europe and worldwide is 5mm smaller (at 20mm) than the maximum Channel Island, UK and Isle of Man Large Letter dimension (25mm).

Parcel¹ (formerly known as Packet)

Minimum Size	Maximum Size
251mm x 354mm Thickness: 0.25mm	Length, + width + height combined = 900mm The greatest single dimension must not exceed - 600mm

Rolled Parcel (formerly known as Rolled Packet)

Minimum Size	Maximum Size
Length + twice diameter - 170mm The greatest single dimension must not be less than - 100mm	Length plus twice diameter must not exceed - 1040mm Length must not be greater than - 900mm

European / Rest of World Postal Rates

International Tracked formerly Airsure



Benefits:

- Priority handling.
- Items electronically tracked up to final delivery overseas (but no signature on delivery).
- Automatic insurance up to £50.
- Up to £250 insurance available (exclusions apply, subject to destination and payment of additional fee of £3.00).
- Proof of posting.
- Available to 50 countries (see table above-right).
- *In some countries only* - Returned free of charge if not delivered, providing the return address is supplied.

Allow 3-5 working days for International Tracked items sent to Europe, and 5-10 working days for items to worldwide destinations.

Maximum compensation for cash and money,¹ and musical instruments sent via International Tracked is £100. Additional compensation is not available for electronic devices such as mobile telephones, smart phones, tablets, notebooks, personal digital assistants and Blackberrys. Standard compensation is £50.

Loss claims for International Tracked to Europe should not be submitted until 20 working days after the estimated delivery date, for items worldwide allow 25 days. All loss claims must be submitted within 6 months of the postal date. See website for details.

¹Cash/money includes coins, notes of any currency, securities of any kind payable to the bearer, travellers cheques and postal orders.

For a fast, secure and reliable international service, International Tracked is hard to beat for sending a Letter, Large Letter or Parcel. Available from all Guernsey Post branches, International Tracked comes with electronic tracking and operates to 50 countries, although it is not time guaranteed.

International Tracked delivers to the following European and Worldwide Countries:

European Countries:

Aland Islands	Faroe Islands	Ireland (Rep. of)	Poland (EU)	Sweden (EU)
Andorra (EU)	Finland (EU)	Italy (EU)	Portugal (EU)*	Switzerland**
Austria (EU)	France (EU) **	Latvia (EU)**	Ireland (Rep.) (EU)	Turkey
Belgium (EU)	Germany	Liechtenstein	Russian Fed.	Vatican City State (EU)
Canary Isles (EU)	Gibraltar	Lithuania (EU)	San Marino (EU)	
Croatia (EU)	Greece	Luxembourg (EU)	Serbia	
Cyprus (EU)	Greenland	Malta (EU)	Slovak Rep. (EU)	
Denmark (EU)	Hungary (EU)	Netherlands (EU)	Slovenia (EU)	
Estonia (EU)	Iceland	Norway	Spain (EU)	

Other Countries:

Australia**	India	Malaysia	Sth Korea
Canada	Israel	New Zealand**	USA
Hong Kong	Lebanon	Singapore	

(EU) - Member of European Union. *Additional insurance is not available. **Please note that these International Tracked countries do not allow cash to be sent through their postal networks.

Letter Postage + £6.05

Item weight not over	Europe	Rest of World
20g	£6.81	£6.90
100g max	£7.59	£8.36

Europe/Rest of World Dimensions for International Tracked & Signed

Postcard

Minimum Size	Maximum Size
90mm x 140mm	120mm x 235mm

Letter

Minimum Size	Maximum Size
90mm x 140mm Thickness: 0.25mm	240mm x 165mm Thickness: 5mm

Large Letter

Minimum Size	Maximum Size
166mm x 241mm Thickness: 0.25mm	353mm x 250mm Thickness: 20mm*

* Please note that the maximum Large Letter depth to Europe and worldwide is 5mm smaller (at 20mm) than the maximum Channel Island, UK and Isle of Man Large Letter dimension (25mm).

Parcel ¹ (formerly known as Packet)

Minimum Size	Maximum Size
251mm x 354mm Thickness: 0.25mm	Length, + width + height combined = 900mm The greatest single dimension must not exceed - 600mm

Rolled Parcel (formerly known as Rolled Packet)

Minimum Size	Maximum Size
Length + twice diameter - 170mm The greatest single dimension must not be less than - 100mm	Length plus twice diameter must not exceed - 1040mm Length must not be greater than - 900mm

Large Letter Postage + £6.05

Item weight not over	Europe	Rest of World
100g	£7.86	£8.80
250g	£9.54	£11.62
500g	£11.66	£15.50
750g	£14.51	£17.30

Parcel¹ Postage + £6.05

Item weight not over	Europe	Rest of World
100g	£8.32	£9.84
250g	£10.12	£12.09
500g	£12.55	£16.05
1000g	£18.31	£21.75
1500g	£23.95	£27.25
2gk max	£29.59	£32.75

For more information on individual country exclusions, please contact Customer Services.

European / Rest of World Postal Rates

International Signed



Benefits:

- Global coverage, covers 169 countries.
- International standard service and delivery times.
- Automatic insurance up to £50.
- Up to £250 insurance available (exclusions apply, subject to destination and payment of additional fee of £3.00).
- Online tracking in the UK.
- Signature taken on delivery (copy not available).
- Proof of posting.
- *In some countries only* - Returned free of charge if not delivered, providing the return address is supplied.

Maximum compensation for cash and money¹, and musical instruments sent via International Signed is £100. Additional compensation is not available for electronic devices such as mobile telephones, smart phones, tablets, notebooks, personal digital assistants and Blackberrys. Standard compensation is £50.

Loss claims for International Signed to Europe should not be submitted until 20 working days after the estimated delivery date, for items worldwide allow 25 days. All loss claims must be submitted within 6 months of the postal date. See website for details.

¹Cash/money includes coins, notes of any currency, securities of any kind payable to the bearer, travellers cheques and postal orders.

For more information on individual country exclusions, contact Customer Services.

International Signed is an International Standard service with signature on delivery (copy of signature not available). For additional security - proof of posting can be requested at the counter. This very useful service can be used for almost every international destination (which is not covered by the International Tracked & Signed Service) and can be purchased at any of our branches.

International Signed delivers to the following European and Countries Worldwide:

European Countries:			Other Countries:
Albania*	Kosovo	Ukraine	Covers countries not listed in Europe. Please contact our Customer Services team for further information or visit our website.
Armenia	Kyrgyzstan	Uzbekistan*	
Azerbaijan	Macedonia		
Bosnia-Herzegovina	Montenegro*		
Estonia (EU)	Norway*		
Kazakhstan*	Tajikistan*		
	Turkmenistan		

*Please note that these International Signed countries do not allow cash to be sent through their postal networks.

Letter Postage + £6.05

Item weight not over	Europe	Rest of World
20g	£6.81	£6.90
100g max	£7.59	£8.36

Large Letter Postage + £6.05

Item weight not over	Europe	Rest of World
100g	£7.86	£8.80
250g	£9.54	£11.62
500g	£11.66	£15.50
750g	£14.51	£17.30

Parcel¹ Postage + £6.05

Item weight not over	Europe	Rest of World
100g	£8.32	£9.84
250g	£10.12	£12.09
500g	£12.55	£16.05
1000g	£18.31	£21.75
1500g	£23.95	£27.25
2000g max	£29.59	£32.75

Europe/Rest of World Dimensions for International Tracked & Signed

Postcard

Minimum Size	Maximum Size
90mm x 140mm	120mm x 235mm

Letter

Minimum Size	Maximum Size
90mm x 140mm Thickness: 0.25mm	240mm x 165mm Thickness: 5mm

Large Letter

Minimum Size	Maximum Size
166mm x 241mm Thickness: 0.25mm	353mm x 250mm Thickness: 20mm*

* Please note that the maximum Large Letter depth to Europe and worldwide is 5mm smaller (at 20mm) than the maximum Channel Island, UK and Isle of Man Large Letter dimension (25mm).

Parcel¹ (formerly known as Packet)

Minimum Size	Maximum Size
251mm x 354mm Thickness: 0.25mm	Length, + width + height combined = 900mm The greatest single dimension must not exceed - 600mm

Rolled Parcel (formerly known as Rolled Packet)

Minimum Size	Maximum Size
Length + twice diameter - 170mm The greatest single dimension must not be less than - 100mm	Length plus twice diameter must not exceed - 1040mm Length must not be greater than - 900mm

European / Rest of World Large Parcel Weight Limits

COUNTRY	GLOBAL PRIORITY MAX WEIGHT (kg)	GLOBAL VALUE MAX WEIGHT (kg)	COUNTRY	GLOBAL PRIORITY MAX WEIGHT (kg)	GLOBAL VALUE MAX WEIGHT (kg)
ALBANIA	30	20	ECUADOR	30	30
ALGERIA	20	20	EGYPT	30	20
ANDORRA	30	20	EL SALVADOR	30	20
ANGOLA	30	20	EQUATOR. GUINEA	30	30
ANGUILLA	20	20	ERITREA	30	20
ANTIGUA & BAR.	30	20	ESTONIA	30	30
ARGENTINA	20	20	ETHIOPIA	30	30
ARMENIA	20	20	FALKLAND ISLES	30	30
ARUBA	20	30	FAROE ISLANDS	30	30
AUSTRALIA	30	30	FIJI	30	20
AUSTRIA	30	30	FINLAND	30	30
AZERBAIJAN	30	30	FR. GUIANA	20	20
AZORES	30	30	FR.POLYNESIA	30	30
B. VIRGIN ISLES	30	20	FRANCE	30	30
BAHAMAS	10	10	GABON	30	20
BAHRAIN	20	20	GAMBIA	10	30
BALEARIC ISLES	30	20	GAZA & KHAN	30	30
BANGLADESH	20	20	GEORGIA	30	20
BARBADOS	30	20	GERMANY	30	30
BELARUS	20	30	GHANA	30	30
BELGIUM	30	30	GIBRALTAR	20	20
BELIZE	30	30	GREECE	30	20
BENIN	30	30	GREENLAND	20	30
BERMUDA	20	20	GRENADA	30	30
BHUTAN	30	20	GUADALOUPE	20	20
BOLIVIA	30	20	GUAM	30	30
BOSNIA-HERZE.	30	20	GUATEMALA	30	20
BOTSWANA	30	30	GUINEA	20	30
BRAZIL	30	30	GUINEA BISSAU	N/A	30
BRITISH VIRGIN ISLES	30	20	GUYANA	30	20
BRUNEI DARUSSALAM	30	30	HAITI	30	30
BULGARIA	30	30	HONDURAS	30	30
BURKINA FASO	30	30	HONG KONG	30	30
BURUNDI	30	30	HUNGARY	30	20
C. AFRICAN REP	30	30	ICELAND	30	30
CAMBODIA	30	30	INDIA	30	20
CAMEROON	30	30	INDONESIA	30	30
CANADA	30	30	IRAN	20	20
CANARY ISLES	20	30	ISRAEL	20	20
CAPE VERDE ISLES	30	20	ITALY	30	30
CAYMAN ISLES	10	20	IVORY COAST	30	30
CHAD	30	20	JAMAICA	30	30
CHILE	30	20	JAPAN	30	30
CHINA (Republic of)	30	30	JORDAN	30	30
CHRISTMAS ISLE	20	20	KAZAKHSTAN	20	20
COCOS ISLAND	20	30	KENYA	30	30
COLOMBIA	20	30	KYRGYZSTAN	30	20
COMOROS	30	20	KIRIBATI	20	20
CONGO (DEM. REP.)	30	20	KOREA (SOUTH)	30	20
CORSICA	30	30	KOSOVO	N/A	20
COSTA RICA	30	30	KUWAIT	30	30
CROATIA	30	30	LAOS	30	30
CUBA	5	5	LATVIA	30	20
CYPRUS	30	30	LEBANON	30	30
CZECH REPUBLIC	30	30	LESOTHO	30	20
DENMARK	30	20	LIBERIA	30	20
DJIBOUTI	20	20	LIBYA	N/A	20
DOMINICA	30	20	LIECHTENSTEIN	20	30
DOMINICAN REP.	30	30	LITHUANIA	30	30

European / International Large Parcel Weight Limits

COUNTRY	GLOBAL PRIORITY MAX WEIGHT (kg)	GLOBAL VALUE MAX WEIGHT (kg)	COUNTRY	GLOBAL PRIORITY MAX WEIGHT (kg)	GLOBAL VALUE MAX WEIGHT (kg)
LUXEMBOURG	30	30	SARDINIA	30	20
MACAO	30	30	SAUDI ARABIA	30	30
MACEDONIA	30	30	SENEGAL	30	30
MADAGASCAR	30	20	SERBIA	30	30
MADEIRA	30	20	SEYCHELLES	30	30
MALAWI	20	30	SIERRA LEONE	30	30
MALAYSIA	30	30	SINGAPORE	30	30
MALDIVES	30	30	SLOVAK REPUBLIC	30	30
MALI	30	30	SLOVENIA	30	30
MALTA	30	30	SOLOMON ISLES	30	30
MARSHALL ISLES	20	20	SOUTH AFRICA	30	30
MARTINIQUE	30	20	SPAIN	30	30
MAURITANIA	30	30	SRI LANKA	30	30
MAURITIUS	30	20	ST HELENA	N/A	N/A
MEXICO	30	20	ST KITTS & NEVIS	30	20
MICRONESIA	20	30	ST LUCIA	20	20
MOLDOVA	30	30	ST PIERRE/MIQ.	30	30
MONACO	30	30	ST VINCENT	30	30
MONGOLIA	N/A	20	SUDAN	30	30
MONTENEGRO	30	30	SURINAME	30	30
MONTSERRAT	30	20	SWAZILAND	30	30
MOROCCO	30	30	SWEDEN	30	30
MOZAMBIQUE	30	30	SWITZERLAND	30	30
MYANMAR	N/A	20	SYRIA	30	30
NAMIBIA	30	20	TAIWAN	30	30
NAURU ISLAND	30	30	TAJKISTAN	N/A	30
NEPAL	20	20	TANZANIA	30	30
NETH. ANTILLES	30	30	THAILAND	30	30
NETHERLANDS	30	30	TIMOR-LESTE	20	10
NEW CALEDONIA	30	30	TOGO	30	20
NEW ZEALAND	30	30	TONGA	N/A	30
NICARAGUA	30	30	TRINIDAD & TOB.	30	20
NIGER REPUBLIC	30	20	TRIST. DA CUNHA	N/A	20
NORTH KOREA	30	20	TUNISIA	30	30
NORWAY	30	30	TURKEY	30	30
OMAN	30	30	TURKMENISTAN	10	20
PAKISTAN	30	30	TURKS & CAICOS	30	20
PANAMA	30	30	TUVALU	30	30
PAP. NEW GUINEA	25	25	UAE	30	30
PARAGUAY	30	30	USA	30	30
PERU	30	30	UGANDA	30	30
PHILIPPINES	20	20	UKRAINE	20	30
PITCAIRN ISLES	N/A	30	URUGUAY	20	30
POLAND	30	20	UZBEKISTAN	N/A	30
PORTUGAL	30	30	VANUATU	20	30
PUERTO RICO	30	20	VATICAN CITY	30	30
QATAR	20	30	VENEZUELA	30	30
REP. IRELAND	30	30	VIETNAM	30	20
REUNION ISLES	30	20	WALLIS&FUT ISL.	30	30
ROMANIA	30	30	WESTERN SAMOA	20	20
RUSSIAN FED.	30	20	YEMEN REP. of	30	30
RWANDA	30	30	ZAMBIA	30	30
SAN MARINO	30	30	ZIMBABWE	20	30
SAO TOME & PRINC.	30	20			